



75A SCRs

TYN1680/1880 Serial

Main Features:

$I_{T(RMS)}$	V_{DRM}/V_{RRM}	I_{GT}
75A	1600V and 1800 V	10 - 80 mA

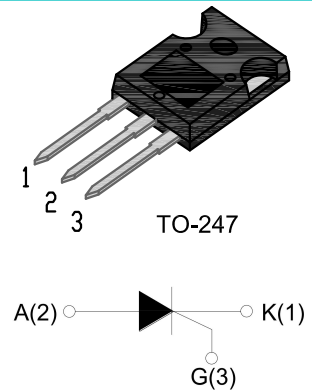

Description:

TYN1680/1880 series of silicon controlled rectifiers, with high ability to withstand the shock loading of large current, provide high dv/dt rate with strong resistance to electromagnetic interference. They are especially recommended for use on solid state relay, motorcycle, power charger, T-tools etc.

Absolute Ratings(limiting values) :

Symbol	Parameter		Value	Unit
T_{stg}	Storage junction temperature range		- 40 to + 150	°C
T_j	Operating junction temperature range		- 40 to + 125	°C
$I_{T(AV)}$	Average on-state current	TO-247 (TC=80°C)	70	A
$I_{T(RMS)}$	RMS on-state current	Lead Current Limitation	75	A
I_{TSM}	Non repetitive surge peak on-state current (tp=10ms)		800	A
V_{DRM}	Repetitive peak off-state voltage(Tj =25°C)		1600 and 1800	V
V_{RRM}	Repetitive peak reverse voltage(Tj =25°C)		1600 and 1800	V
I^2t	I^2t value for fusing tp = 10 ms		5000	A ² s
dI/dt	Critical rate of rise of on-state current ($I_G = 2 \times I_{GT}$)		150	A/μs
I_{GM}	Peak gate current		2.5	A

P_{G(AV)}	Average gate power dissipation	2	W
P_{GM}	Peak gate power	10	W

Electrical Characteristics : (T_j=25°C unless otherwise specified)

Symbol	Test Condition	Value			Unit
		MIN	TYP	MAX	
I_{GT}	V _D =12V R _L =30Ω	10	-	80	mA
V_{GT}		--	-	1.5	V
V_{GD}	V _D =V _{DRM} T _j =125°C	0.25	--	--	V
I_L	I _G =1.2 I _{GT}	--	--	200	mA
I_H	I _T = 1A	--	--	150	mA
dv/dt	V _D =2/3V _{DRM} Gate Open T _j =125°C	1000	--	1000	V/μs

STATIC CHARACTERISTICS

Symbol	Parameter		Value(MAX)	Unit
V_{TM}	I _{TM} = 100A tp= 380μs	T _j =25°C	1.55	V
I_{DRM} I_{RRM}	V _D =V _{DRM} , V _R =V _R RM	T _j =25°C	50	μ A
		T _j =125°C	10	mA

Thermal Resistances :

Symbol	Parameter	Value	Unit
R_{th(j-c)}	junction to case(DC)	TO-247	0.32 °C/W

Fig.1: Maximum power dissipation versus RMS on-state current

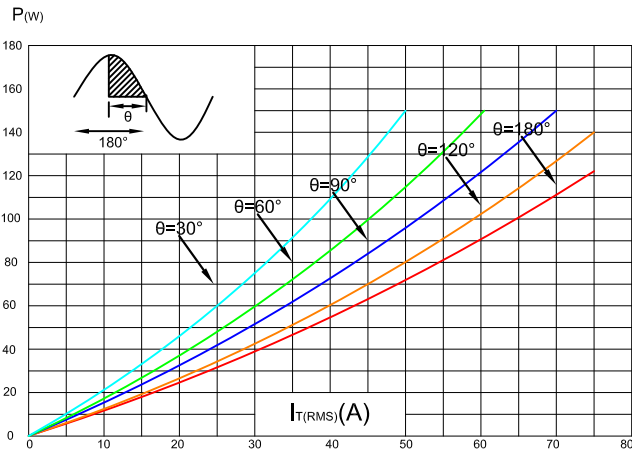

Fig.2 : RMS on-state current versus case temperature

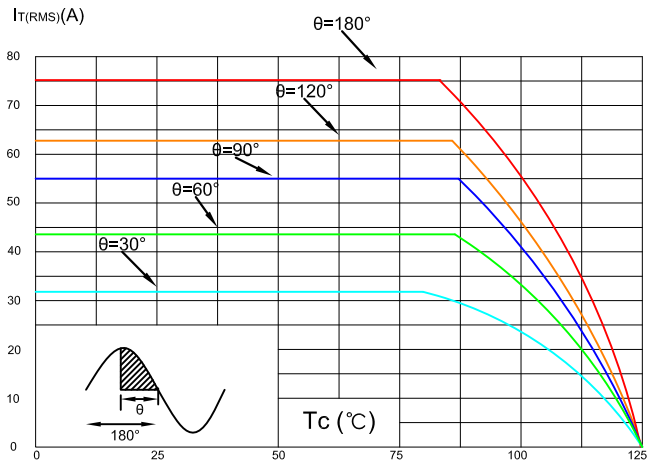

Fig.3 : Surge peak on-state current versus number of cycles

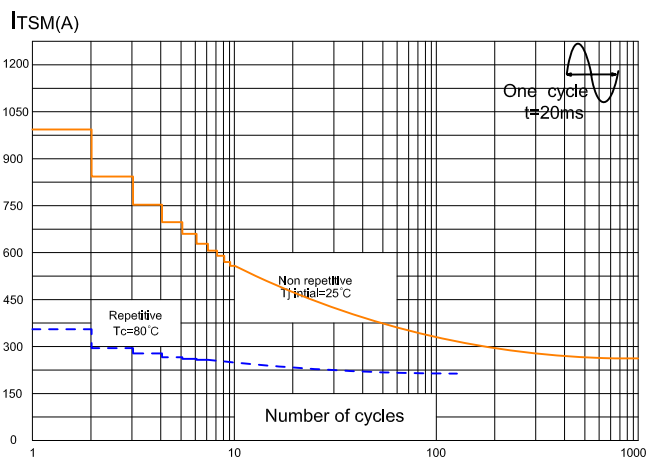

Fig.4 : On-state characteristics (maximum values)

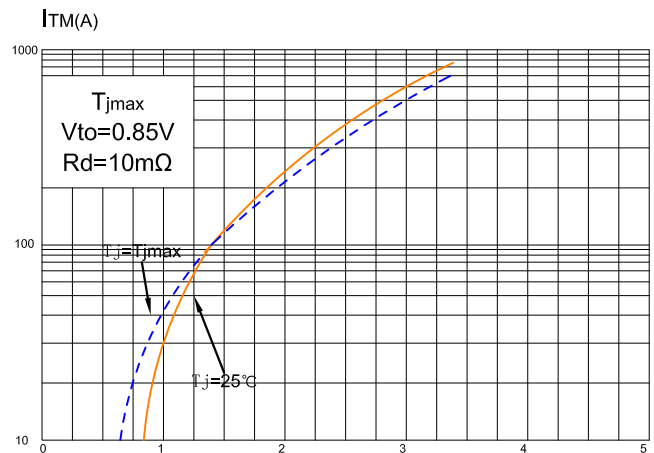

Fig.5 : Non-repetitive surge peak on-state current for a sinusoidal pulse with width $t_p < 10ms$ and corresponding value of $I^2 t$ ($di/dt < 50A/\mu s$)

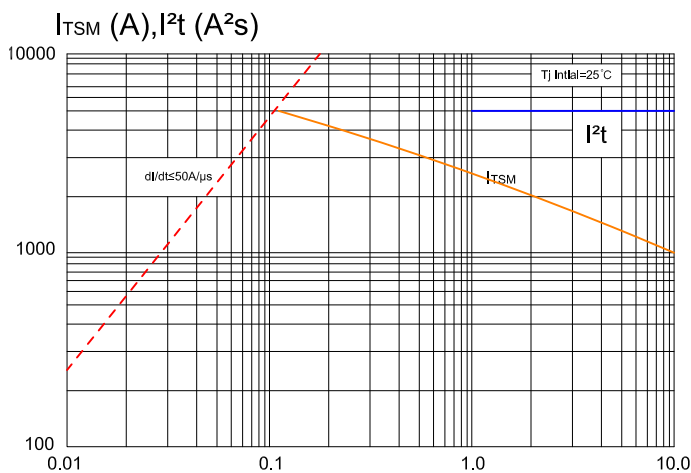
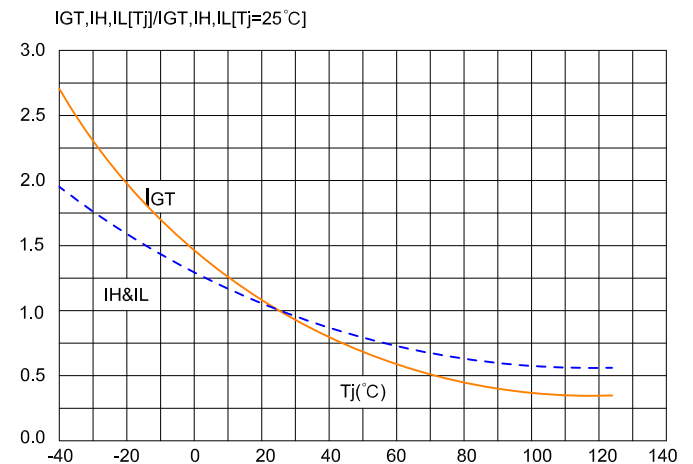
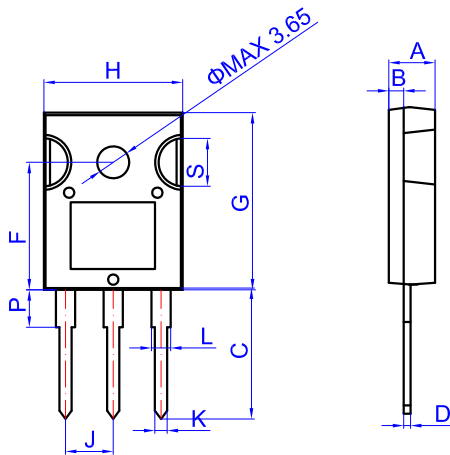

Fig.6: Relative variations of gate trigger current versus junction temperature



Package Mechanical Data :

TO-247



Ref.	Dimensions					
	Millimeters			Inches		
	Min.	Typ.	Max.	Min.	Typ.	Max.
A	4.9		5.4	0.193		0.213
B	1.6		2.0	0.063		0.079
C	14.35		15.4	0.565		0.606
D	0.5		0.8	0.020		0.031
F	14.4		15.1	0.567		0.594
G	19.7		20.6	0.775		0.811
H	15.4		16.2	0.606		0.638
J	5.3		5.6	0.209		0.220
K	1.3		1.5	0.051		0.059
L	2.8		3.3	0.110		0.130
P	3.7		4.2	0.146		0.165
S	5.35		5.65	0.211		0.222

Ordering Information:

